

Exercise Sheet 12: Centrality Measures

Maximilian Marx, Markus Krötzsch
 Knowledge Graphs, 2020-02-09, Winter Term 2020/2021

Exercise 12.1. Consider the directed graph G given by the diagram below. Compute the first three partial sums of the Katz centrality values for each vertex of G (use $\alpha = 0.5$):

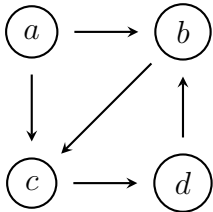

Exercise 12.2. Let $G = \langle V, E \rangle$ be an undirected graph. A *bi-clique* in G consists of two disjoint, nonempty sets $A, B \subseteq V$ such that the induced subgraph of $A \cup B$ in G is a complete bipartite graph, i.e., $\{\{a, b\} \mid a \in A, b \in B\} \subseteq E$, and no two vertices in A (and B , respectively) are adjacent.

Find all bi-cliques in the following graph. Which bi-cliques are maximal?

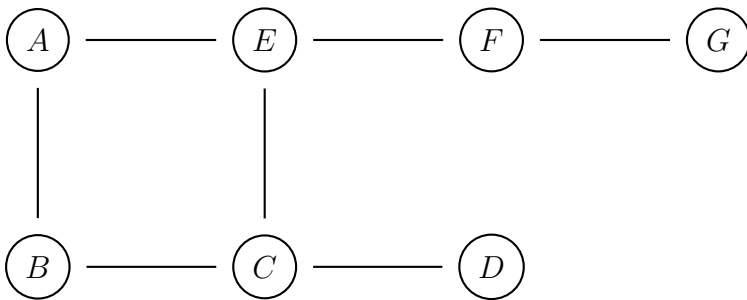

Exercise 12.3. Let $G = \langle V, E \rangle$ be a directed graph. For two vertices $v, w \in V$, the *distance* $d(v, w)$ is the length of the shortest directed path from v to w (or ∞ if there is no such path). For a set $S \subseteq V$ of vertices, the *reachable set* is $R(S) := \{v \in V \mid \exists w \in S. d(w, v) < \infty\}$. A *point base* of G is a minimal set $B \subseteq V$ such that $R(B) = V$.

Find a point base for the following graph. How does the point base change when adding the edge $\langle B, E \rangle$?

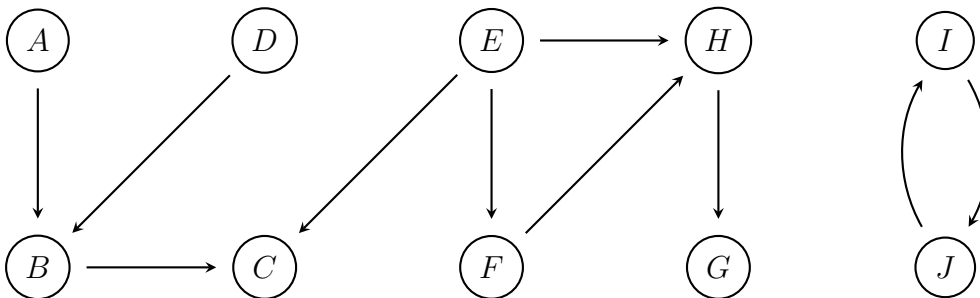

Exercise 12.4. Write a program that takes as input

- a directed graph in METIS format
- and a dictionary file in the format of Exercise 12.4 mapping vertex IDs to labels,

and outputs the vertex labels of the given graph, ordered by (decreasing) Betweenness.

Run your program on the Routing Information Base data set¹, a snapshot of the global Internet routing table: every vertex corresponds to an independently operated network (a so-called *Autonomous System*), such as a university, a company, or an internet provider, and an edge from v to w is present if there is some route in which traffic flows from v to w .

What are the twenty most important *Autonomous Systems* in terms of Betweenness?

Hint: NetworkKit² is a Python library that has an efficient implementation of Betweenness.³

¹<https://github.com/knowsys/Course-Knowledge-Graphs/tree/master/data/rib>

²<https://networkkit.github.io>

³https://networkkit.github.io/dev-docs/python_api/centrality.html